

NS372TB3

1U Rackmountable 2-bay (5.25") LTO Tape Drive to
Thunderbolt™ 3 Enclosure



User Manual

Third edition, Feb. 2021

1. Unpack the NS372TB3	3
2. Storage Enclosure Description	3
2.1 Panel Layout	3
2.2 Environmental Control Board LED Status	5
3. Setup Procedure	6
4. Blower Fan Speed Adjustment	10
5. Power On/Off NS372TB3	11
6. Verification	12
6.1 macOS	12
6.2 Windows Operating System	14
7. Thunderbolt 3 Card LEDs Status	15

1. Unpack the NS372TB3

The box contains the following items:

- Netstor NS372TB3 storage
- Thunderbolt 3 cable (1 meter) × 1
- Power cord × 1

2. Storage Enclosure Description

2.1 Panel Layout

1. Mute Button

- Mute Buzzer Beeping



2. Fan LED

- Green – normal
- Red – fan failure (low frequency of RPM or stop)

3. Temperature LED

- Green – normal
- Red – over 50°C

**9. Thumbscrews to loosen/
tighten the top cover**

4. Power Cord Receptacle



8. SFF-8088 mini-SAS Port

- This mini-SAS port is for connecting to device such as external LTO or external HDD enclosure.

5. Hot-Swappable Blower Fan 1

- 75 × 75 × 28 mm

6. Hot-Swappable Blower Fan 2

- 75 × 75 × 28 mm

7. Thunderbolt 3 Connectors

- Connecting Thunderbolt 3 cables to host and downstream device

2.2 Environmental Control Board LED Status

D2 LED: fan failure indicator

- D2 LED no light: both blower fan 1 and 2 are normal
- D2 LED red light: either blower fan 1 or 2 fails

D4 LED: fan 1 status

- D4 LED no light: blower fan 1 is normal
- D4 LED red light: blower fan 1 fails

D5 LED: fan 2 status

- D5 LED no light: blower fan 2 is normal
- D5 LED red light: blower fan 2 fails

Example:

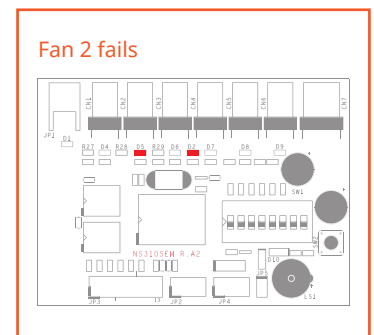
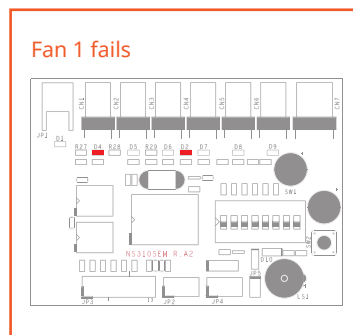
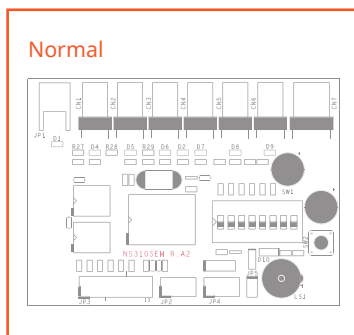

3. Storage Setup Procedure

1. Place NS372TB3 storage on a level surface on a stable table. By front, the left 5.25" slot is the first bay, and the right 5.25" slot is the second bay.



2. Loosen the two thumbscrews at rear of the enclosure, and open the top cover.

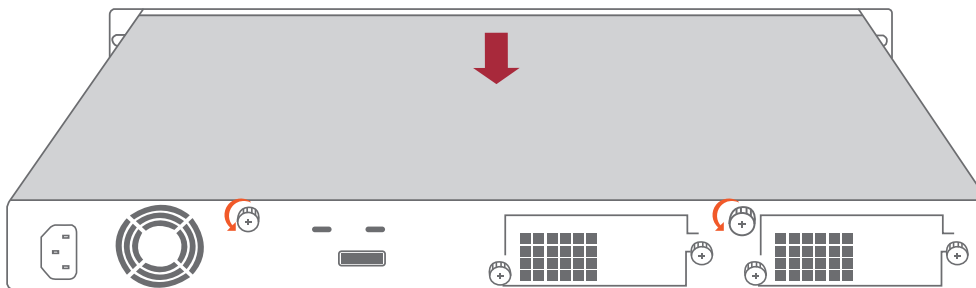

3. Firstly, take the first drive slot for instance: there are two 5.25" bay covers attached to the front of the storage enclosure. Use a screwdriver to unscrew the two screws on each cover to detach it from the front panel.

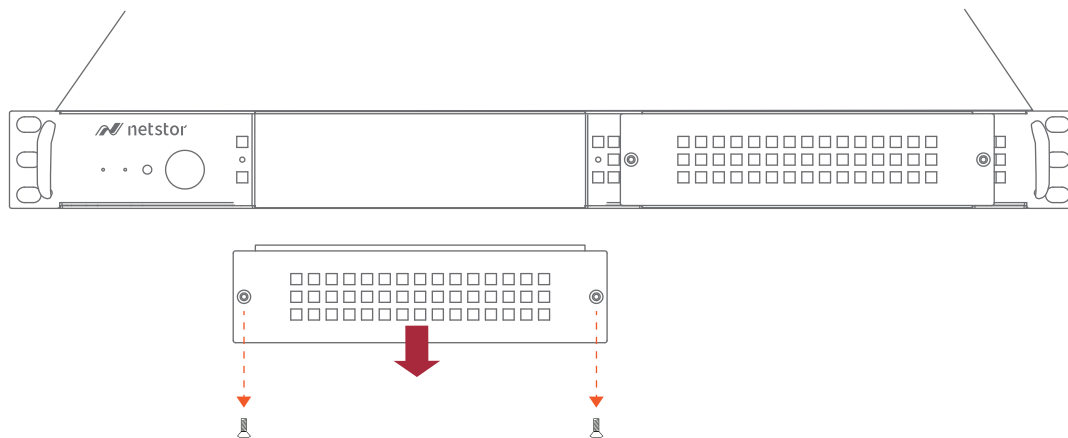

4. Inside the enclosure, there are two sets of metal side brackets for each LTO tape drive.

(a) Detach the first set of metal side brackets by loosening the screws.

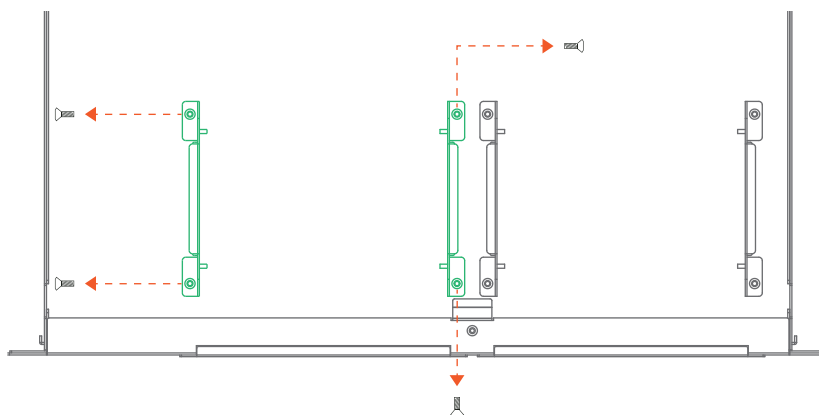

(b) From the front panel, insert the LTO tape drive into the enclosure.

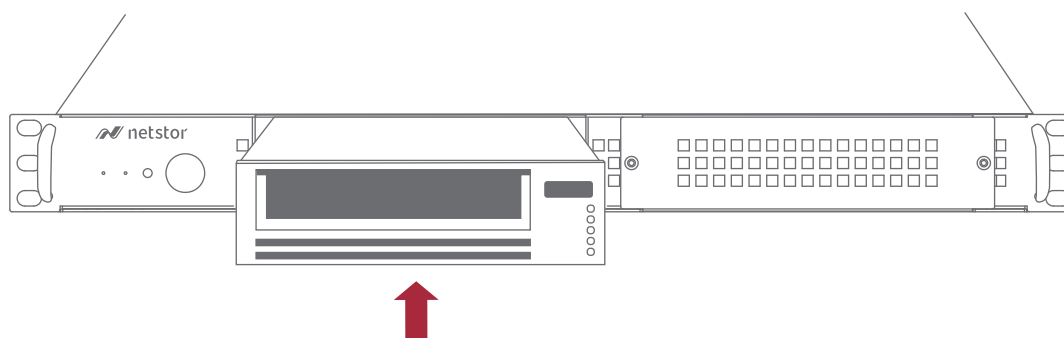

(c) As the tape drive is inserted, attach the set of metal side brackets back to the original position, and fasten the screws on the metal side brackets. Note there are two bosses on each bracket; have the two bosses be inserted into the screw holes on tape drive's side.

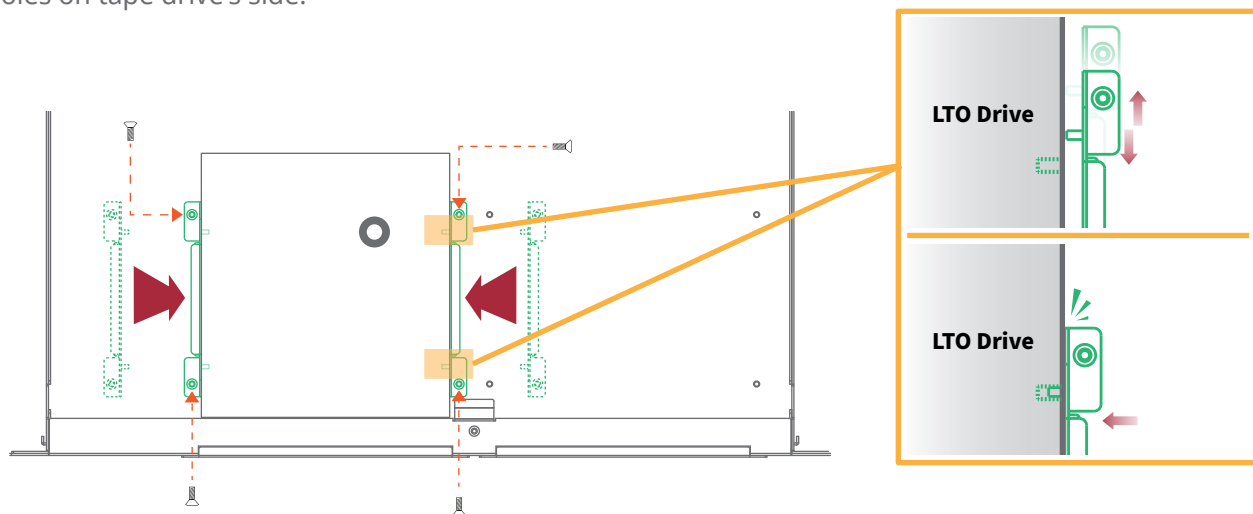

5. From inside the NS372TB3 enclosure, connect the first SFF-8482 connector, labeled P1, to the rear of LTO tape drive for data signal and power source.

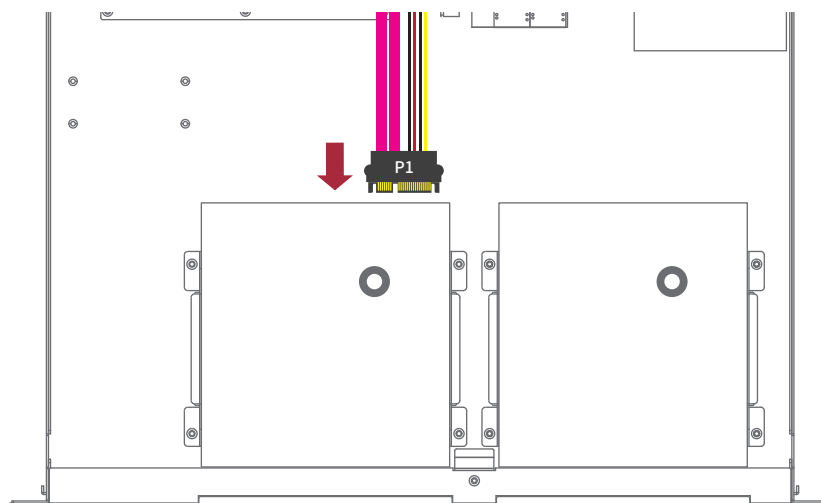

※ Repeat the above steps 3 and 5 for the installation of the second LTO tape drive in the storage enclosure.

6. Put the top cover back to the storage, and fasten the two thumbscrews at rear of the enclosure.

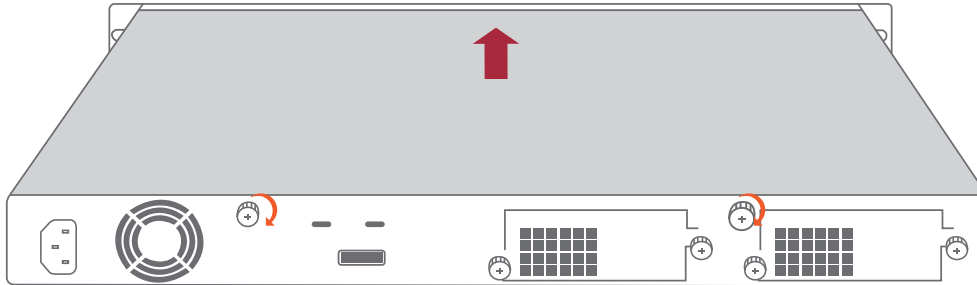

7. Connect NS372TB3 and Thunderbolt 3 computer with Thunderbolt cable, and then connect Netstor storage with power source.

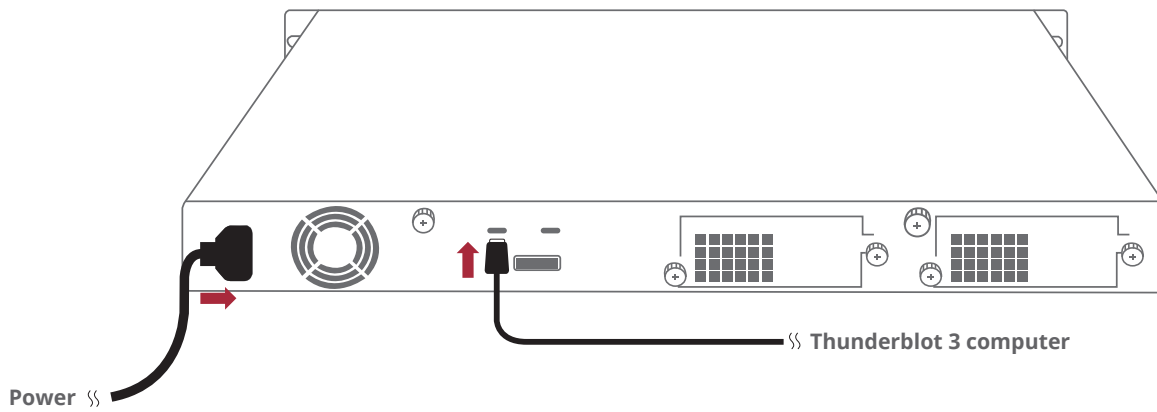

4. Blower Fan Speed Adjustment

1. There are two hot-swappable 75×75×28 mm blower fans for ventilation at rear of NS372TB3. After loosening the two thumbscrews on the fan module, the blower fan can be pulled out of the storage enclosure.

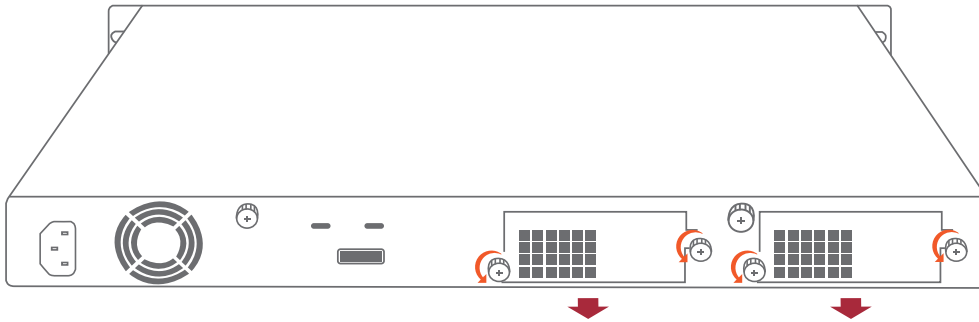

2. The rear 75×75×28 mm blower fan speed can be adjusted. As the blower fan module is pulled out, there are four sets of jumpers labeled with 6V, 8V, 10V, 12V from top to bottom on the fan connector board. The default setting is the jumper being placed over pin 7 and 8 for label 6V for slowest speed. The speed increases from label 8V to label 12V. As jumper is not placed over pins, the fan will spin at 12V full speed.

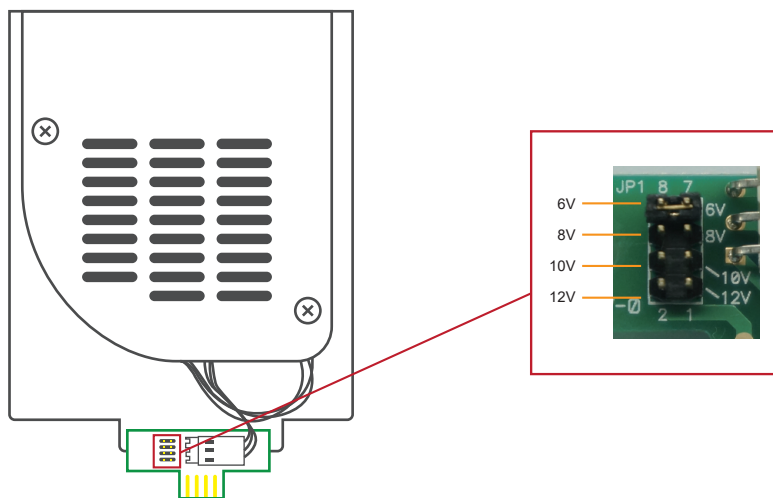

5. Power On/Off NS372TB3

1. NS372TB3 storage is designed to be powered on/off simultaneously with the Thunderbolt 3 computer as NS372TB3 is connected to computer by Thunderbolt cable. Therefore, power on computer first, and then NS372TB3 will be powered on automatically.

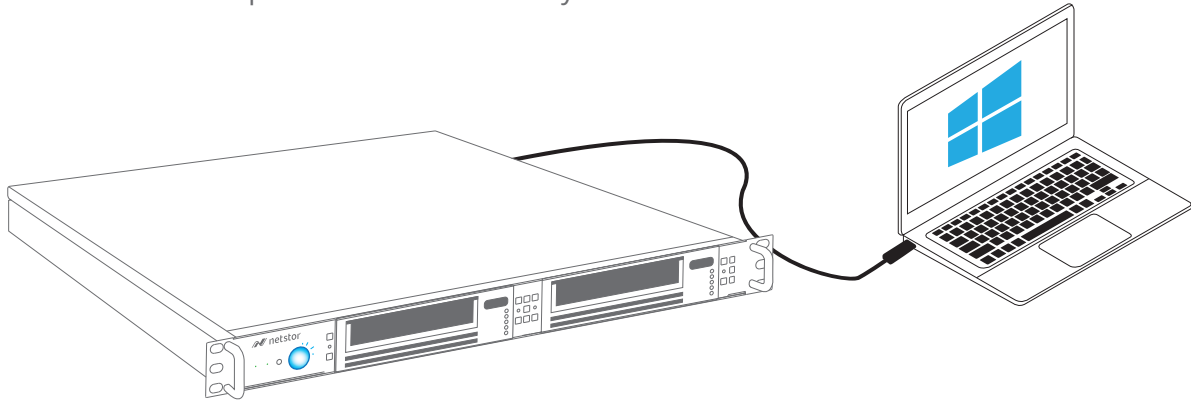

2. As NS372TB3 storage is connected to computer by Thunderbolt cable, when shutting down computer, the NS372TB3 will be shut down automatically as well.

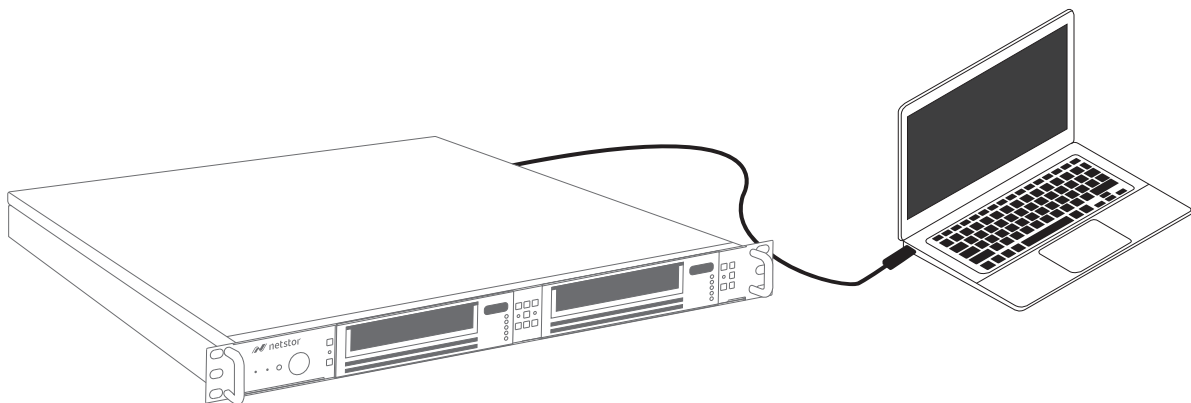

※ NS372TB3 supports hot-plug and hot-unplug for powering on and off.

6. Verification

6.1 macOS

1. Verify Netstor NS372TB3 is recognized by computer. Click Apple icon at the top menu bar, select **About This Mac**, and click **System Report** button. Click **Thunderbolt** in the left column, as NS372TB3 appears in the information, it means Netstor storage is recognized correctly by computer.

2. Verify RAID controller of NS372TB3. Right after the above point 1, click **PCI** in the left column, and information about NS372TB3's Host Bus Adapter will appear. (For Host Bus Adapter, from starting up, it will take more time for its info to be shown)

3. Verify the driver of NS372TB3's Host Bus Adapter. Following point 2, there is an item **Driver Installed** indicating the status of Host Bus Adapter's driver. The driver is already embedded in macOS 10.12 and later.

4. Follow LTO tape drive manufacturer's instructions to install LTO tape drive's GUI program on the macOS for operation.

Note:

The Power Nap function is enabled by default on macOS. With Power Nap enabled, during sleep mode, the background task such as checking for new e-mail, calendar and iCloud updates will cyclically occur. As the background task takes place, all the Mac's interfaces including Thunderbolt 3 will wake up, which will lead to the Thunderbolt 3 device being waked up as well. To avoid this, the user can turn off the Power Nap function; the method to turn it off is as follows:

Go to macOS's System Preferences. Click on '**Energy Saver**'. Then you will see an item '**Enable Power Nap**'. The default setting is there is a check being put to this item. Uncheck the item to disable the Power Nap function on macOS.

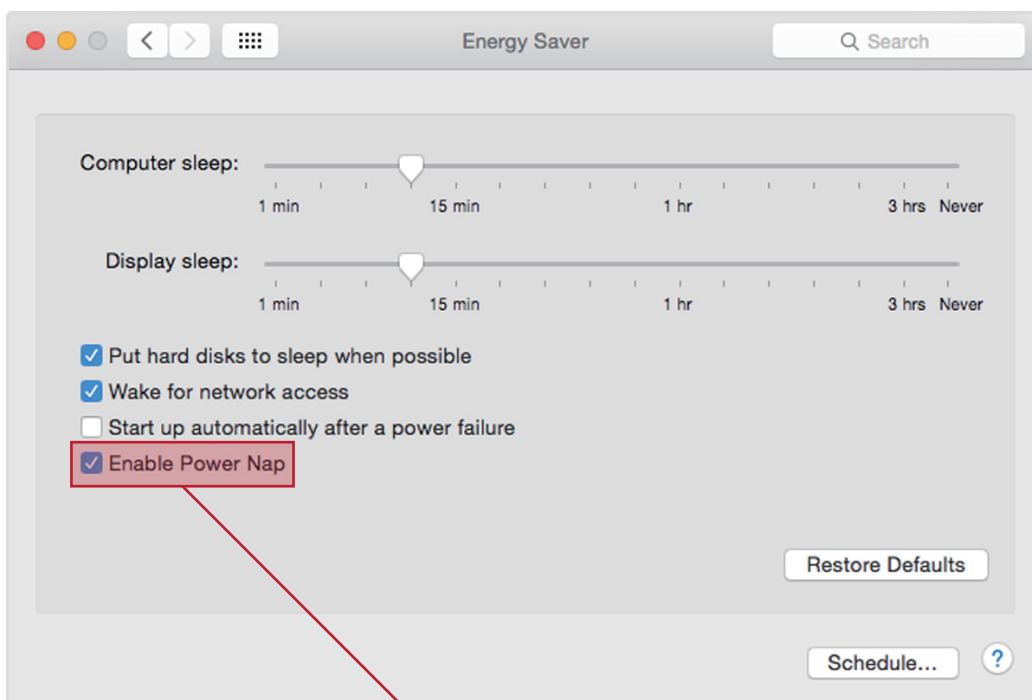

Uncheck the item

6.2 Windows Operating System

1. Verify Netstor NS372TB3 is recognized by computer. Right click **This PC**, and select **Manage**. As window of Computer Management pops up, click **Device Manager** in the left column, click **View** at the top menu bar, and select **Devices by connection**.
2. Click **ACPI x64-based PC**, select **Microsoft ACPI-Compliant System**, and click **PCI Express Root Complex**. Open the PCI Express Root Port, and NS372TB3's Host Bus Adapter will be shown, meaning Netstor storage is recognized correctly by computer.
3. Follow LTO tape drive manufacturer's instructions to install LTO tape drive's GUI program on the Windows operating system for operation.

Power-on:

After NS372TB3 is powered on, LED 2 through LED 5 will show green light. At this time, if a USB device or a monitor is daisy chained to the second Thunderbolt 3 port on the Netstor Thunderbolt 3 card, then LED 6 will show green light. On the other hand, provided the second Thunderbolt 3 port is not connected with any device/monitor, LED 6 will not show light.

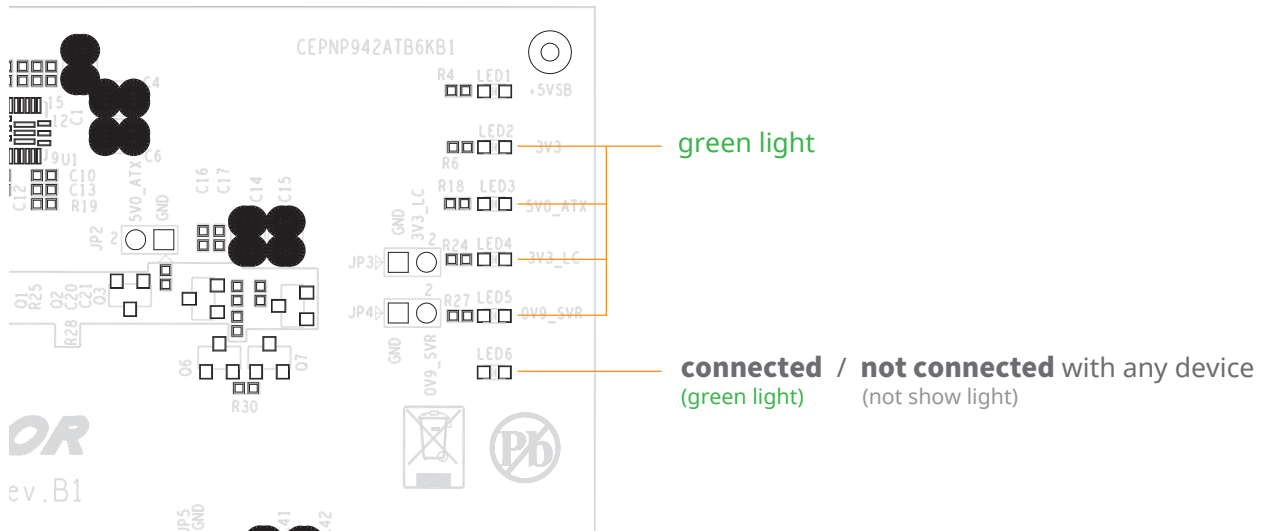

If you have any questions, please contact your regional distributor, or Netstor Technology, Taiwan.



Netstor Technology Co. Ltd.

🏠 6F, No. 1, Alley 16, Lane 235, Baoqiao Rd., Xindian District, New Taipei City 231-45, Taiwan, R.O.C.

🌐 www.netstor.com.tw

✉ sales@netstor.com.tw

☎ +886 2 2917 1500